

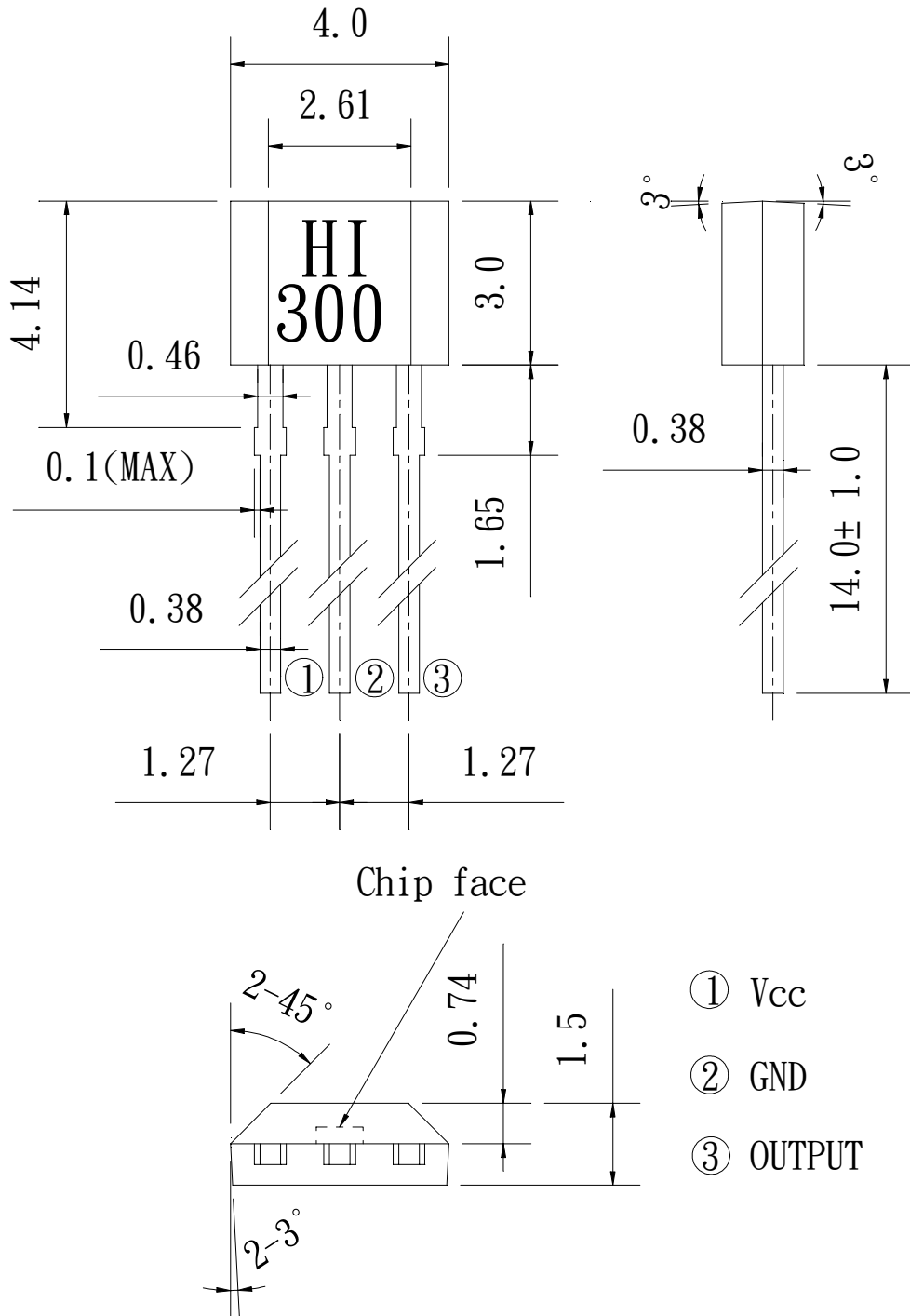

Device Number: DHI-092-005 REV: 1.0
MODEL NO: HI300/D1 ECN: _____ Page: 1/6

PACKAGE DIMENSIONS:





MODEL NO: HI300/D1 **Device Number:** DHI-092-005 **REV:** 1.0
ECN: _____ **Page:** 2/6

■ **NOTES:**

1. This drawing measure is a standard value. All dimensions are in millimeter.
2. In case of designation is tolerance $\pm 0.3\text{mm}$.
3. Lead spacing is measured where the lead emerge from the package.
4. Protruded resin under flange 1.0 mm Max.
5. Lens color : Black.
6. Above specification may be changed without notice. EVERLIGHT will reserve authority on material change for above specification.
7. These specification sheets include materials protected under copyright of EVERLIGHT corporation. Please don't reproduce or cause anyone to reproduce them without EVERLIGHT consent.
8. When using this product, please observe the absolute maximum ratings and the instructions for use outlined in these specification sheets. EVERLIGHT assumes no responsibility for any damage resulting from use of the product which does not comply with the absolute maximum ratings and the instructions included in these specification sheets.

■ **FEATURES:**

1. 3V to 20V operation.
2. No need for reverse voltage.
3. High reliability.
4. Small size.
5. Output compatible with all digital logic families.

■ **APPLICATIONS:**

1. Brushless DC motor.
2. Rotation detection.
3. Displacement detection.
4. Speed sensing.



Device Number: DHI-092-005 REV: 1.0
 MODEL NO: HI300/D1 ECN: _____ Page: 3/6

ABSOLUTE MAXIMUM RATINGS:**(Ta=25°C)**

PARAMTER	SYMBOL	RATING	UNIT	CONDITION
Supply Voltage	V _{CC}	20	V	-
Supply Current	I _{CC}	8	mA	-
Output Current	I _{OUT}	20	mA	-
Maximum Power Dissipation	P _D	100	mW	-
Operating Ambient Temperature	T _A	-20~+85	°C	-
Storage Temperature	T _{STG}	-40~+120	°C	-
Soldering Temperature	T _{SOL}	260	°C	1/16 inch from body for 5 seconds

ELECTICAL CHARACTERISTICS:**(Ta=25°C)**

PARAMETER	SYMBOL	MIN.	TYP.	MAX.	UNIT	CONDITION
Supply Voltage	V _{CC}	3	-	20	V	Operating
Output Saturation Voltage	V _{SAT}	-	-	0.2	V	I _{OUT} =5mA, B>Bop
Supply Current	I _{CC}	-	3.5	6	mA	Operating
Output Leakage Current	I _{LEAK}	-	0.5	2	μA	V _{OUT} =20V, B>Brp
Output Rise Time	t _r	-	0.4	-	μS	V _{CC} =12V, R _L =4.7kΩ,
Output Rise Time	t _f	-	0.4	-	μS	C _L =20pF

RANKING:**(Ta=25°C)**Condition: V_{CC}=20V

Unit :Gauss

Bin Number	Bin 1	Bin 2	Bin 3	Bin 4
Min	1	55	85	125
Max	70	100	140	200



TYPICAL CHARACTERISTICS CURVES:

Fig. 1 Supply Current V.S. Supply Voltage

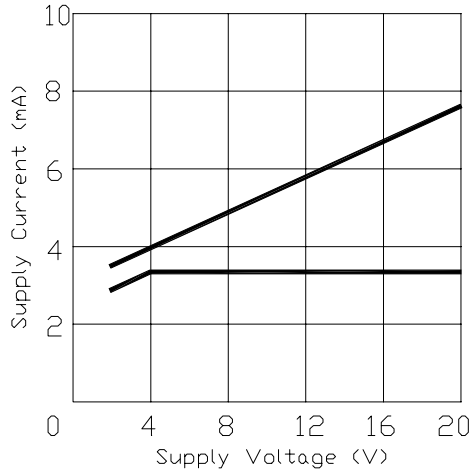

Fig. 2 Output Low Voltage V.S. Supply Voltage

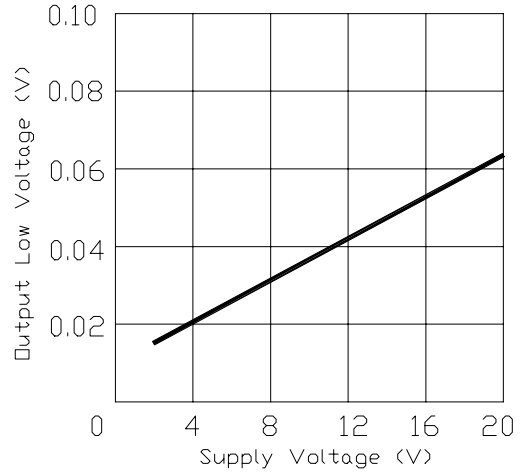

Fig. 3 Switch Points (Bop,Brp) V.S. Supply Voltage

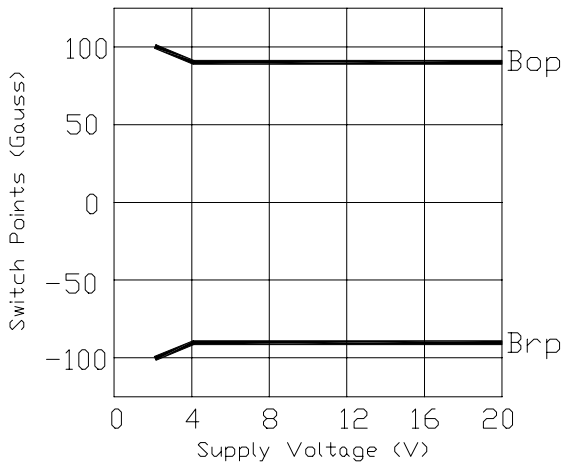

Fig. 4 Switch Points V.S. Ambient Temperature

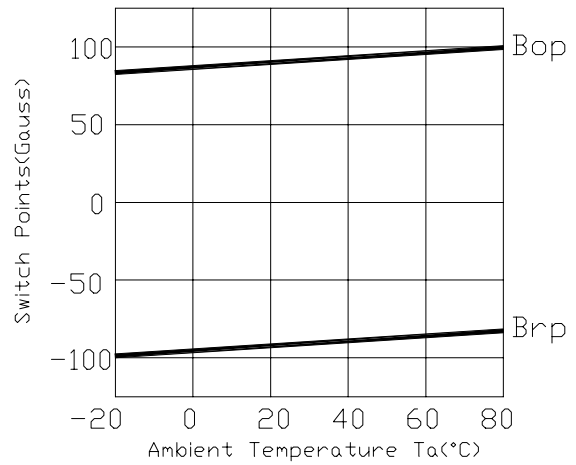

Fig. 5 Supply Current V.S. Ambient Temperature

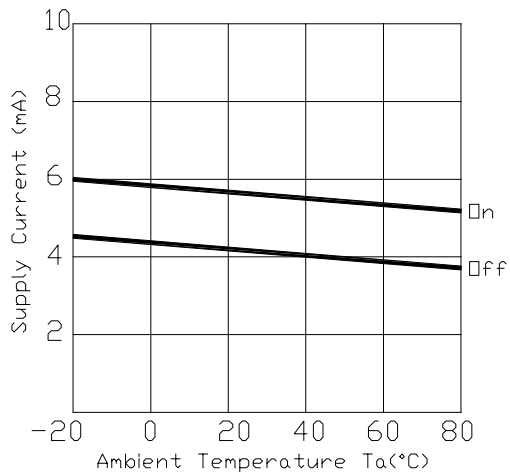
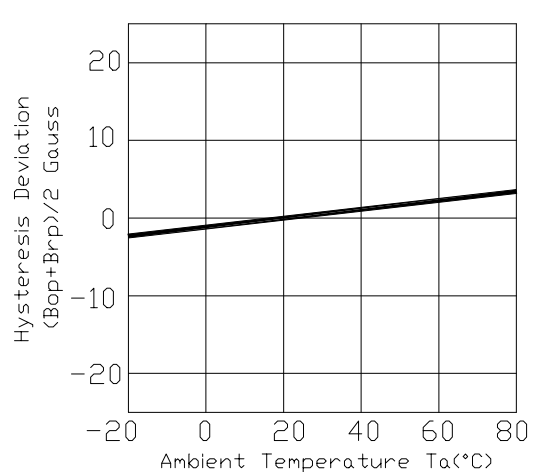

Fig. 6 Hysteresis Deviation V.S. Ambient Temperature





Device Number: DHI-092-005 **REV:** 1.0
MODEL NO: HI300/D1 **ECN:** _____ **Page:** 5/6

FUNCTION BLOCK DIAGRAM:

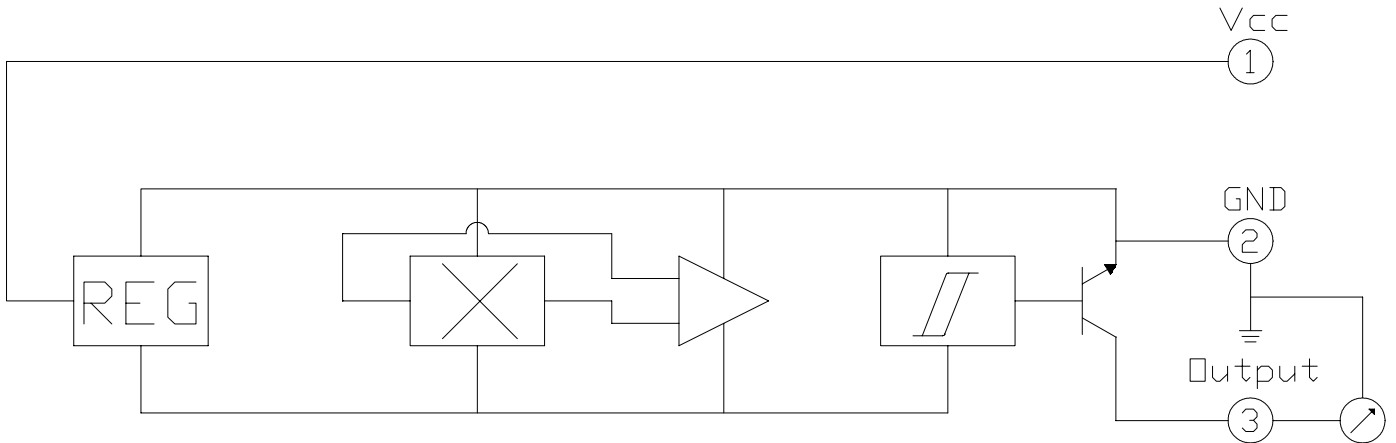

RELIABILITY:

The reliability of products shall be satisfied with items listed below.
 Confidence level : 90%
 LTPD : 10%

TEST ITEMS	TEST CONDITIONS	FAILURE JUDGEMENT CRITERIA	SAMPLES(n)
			DEFECTIVE(c)
Operation life	Vcc=12V, Ta=25°C 1000hrs	L : Lower Specification Limit U : Upper Specification Limit	n=22 , c=0
Temperature cycle	1 cycle -55°C to +85°C (30min) (30min) 50 cycle test		n=22 , c=0
Thermal shock	-10°C to +100°C (5min) (10sec) (5min) 50 cycle test		n=22 , c=0
High temperature storage	Temp : +150°C 1000hrs		n=22 , c=0
Low temperature storage	Temp : -55°C 1000hrs		n=22 , c=0
High temperature High humidity	TA : 85°C RH : 85% 1000hrs		n=22 , c=0
Solder heat	Temp : 260 ± 10°C sec 4mm Form the bottom of the package		n=22 , c=0



Device Number: DHI-092-005 REV: 1.0
MODEL NO: HI300/D1 ECN: _____ Page: 6/6

PACKING SPECIFICATIONS: (UNIT : mm)

1. Bag:

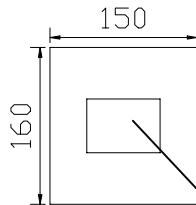

3. Carton:

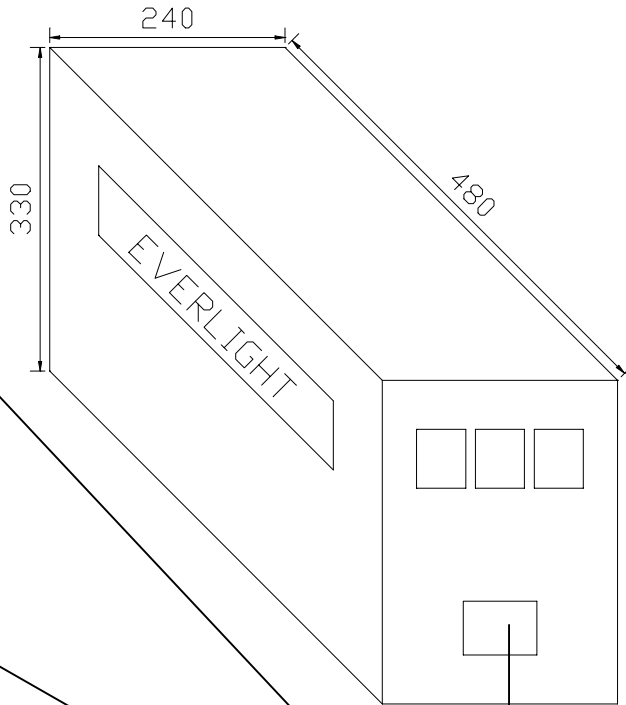

2. Box:

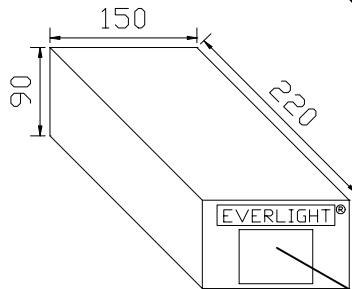

Packing Quantity Specification:

- 1. 1000Pcs/1bag, 10bags/1box
- 2. 10boxes/1Carton

Label Specification:

- CPN : Customer's Production Number
- P/N : Production Number
- QTY : Packing Quantity
- CAT : Ranks
- HUE : Reference
- REF : Reference
- LOT NO : Lot Number
- MADE IN TAIWAN : Production place

Label